

**Shibaura Machine**

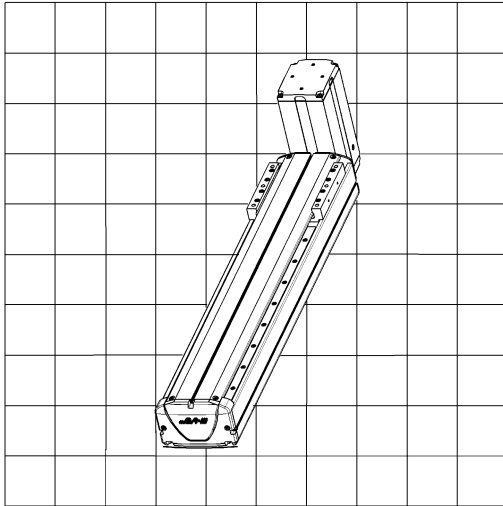

# COMPO ARM

*BA-III* SERIES

MODEL : BE10  
Belt-Driven Actuator

## ACTUATOR INSTRUCTION MANUAL

Original Instructions

**Shibaura Machine**

Keep this manual nearby for future reference.

# Introduction

Before using the COMPO ARM BA-III series, read through and completely understand this instruction manual to assure correct use.

For general information for the COMPO ARM BA-III Series, refer to CA25 Instruction Manual (Basic Part).

## CAUTION

1. About application of this product
  - This product is not designed or manufactured to be used in equipment in situations that can affect or endanger human life.
  - When considering this product for operation in special applications (passenger transportation, medical, aerospace, atomic power, electric power, etc.), please contact our sales section.
  - Although this product was manufactured under conditions of strict quality control, you are strongly advised to install safety devices to forestall serious accidents when it is used in facilities where a breakdown in the product is likely to cause a serious accident.
2. This equipment does not have an explosion-proof structure. Take utmost care of the operating environment.
3. All efforts have been made to assure the contents of this manual. If you have any questions, or find any mistakes, however, please contact Shibaura Machine.
4. Shibaura Machine will not be held responsible for any effects caused by using this equipment, regardless of Item 3 above.
5. The contents of this manual are subject to change without prior notice to effect improvements.

Copyright 2022 by SHIBAURA MACHINE CO., LTD..

All rights reserved.

No part of this document may be reproduced in any form without obtaining prior written permission from SHIBAURA MACHINE CO., LTD..

The information contained in this manual is subject to change without notice to effect improvements.

# Contents

Chapter 1	Safety.....	1
■1.1	Cautions for safety.....	1
■1.2	For your safe operation.....	5
■1.3	Warranty.....	9
Chapter 2	Shipment List.....	10
■2.1	Shipment list.....	10
Chapter 3	Axis Specifications.....	11
■3.1	Axis type and names of individual parts.....	11
■3.2	Single axis specification.....	12
Chapter 4	Cable Installation.....	17
Chapter 5	Installing Actuator (Axis).....	18
■5.1	Installing Actuator (Axis).....	19
■5.2	Robot type for each Axis.....	19
■5.3	Parameter values.....	20
Chapter 6	Precautions for Use.....	22
■6.1	Fluctuation in sliding resistance during long-term storage.....	22
■6.2	In the event of collision.....	22
■6.3	About cracks on the back of the timing belt during long-term operation.....	23
■6.4	Servo gain setting.....	24
Chapter 7	Maintenance.....	28
■7.1	Precautions for inspection and maintenance work.....	28
■7.2	Inspection before starting the work.....	29
■7.3	Periodic inspection.....	29
■7.4	Maintenance Schedule.....	30
■7.5	Cleaning.....	32
■7.6	Greasing.....	32
■7.7	Timing belt inspection.....	33
■7.8	Timing belt and motor replacement procedure.....	33
■7.9	Routing the timing belt.....	38
■7.10	Origin position adjustment.....	40
■7.11	Replacement of linear guide.....	41
■7.12	Bolt and screw tightening torque.....	41
Chapter 8	Spare Parts.....	42
■8.1	Spare Parts.....	42

# Overview

- This manual describes the axis type expression method, specifications and motor replacement procedures, etc., according to the type of axis.
- For the installation, see the instruction manual (installation of actuator) provided separately.

## Chapter 1 Safety

### ■ 1.1 Cautions for safety

- Before the installation, programming, operation, maintenance and inspection of the equipment, be sure to read through this manual so that you can use the COMPO ARM with safety.
- After you have read this manual, keep it nearby for future reference.

Be sure to observe the instructions for ensuring operation safety of the COMPO ARM.

This manual contain the important information to prevent injury to the operators and persons nearby, to prevent damage to assets and to assure correct use of the equipment.

Make sure that you have well understood the following details (indications and symbols) before reading this manual.

Always observe the information that is noted.

#### **WARNING**

: If you have neglected this instruction and caused a handling error, death or serious injury may occur.

#### **CAUTION**

: If you have neglected this instruction and caused a handling error, human injury or property damage (damages to houses, household goods and domestic animals) may occur.

#### **CAUTION**

: This gives a brief description of the major points of operation procedures, precautions and method for effective use of the machine.

**⚠ WARNING**

- **Install the safety fences to prevent anyone from entering the working envelope of the robot.**

When the door is attached to the safety fence, the robot should be stopped at emergency at the same time that the door has opened.

- **Connect the EMERGENCY STOP pushbutton switch to the emergency stop input terminal of the controller and mount the same switch at an easy-to-operate place in an emergency.**

The EMERGENCY STOP switch must not be reset automatically and cannot be reset negligently by any person.

- **Wiring should be done safely and completely according to the Electrical Installations Technical Requirements and Interior Wiring Requirements of Japan.**

Incorrect wiring will result in an electric shock or a fire.

- **The equipment MUST NOT be repaired or modified without prior written permission from the manufacturer.**

Otherwise, an accident or damage will be caused.

- **Before the maintenance and inspection, be sure to turn off the controller main power switch. Take all necessary measures to prevent anyone other than the worker engaged in adjustment of the robot from negligently turning the power on. (Lock the switch and put a tag showing "DO NOT turn the power on.") Also, DO NOT touch the controller interior ten (10) minutes after the power is turned off.**

Otherwise, you may get an electric shock due to residual voltage of the capacitor.

- **DO NOT touch the motor, heat sink and cement resistor in the controller.**

They are too hot and you may get burnt. Before performing inspection, take enough time to cool them off.

- **DO NOT pour water on the equipment interior or exterior, or drain water from it. Otherwise, you may get an electric shock, or the equipment will be damaged.**

When the equipment has contaminated, wipe it off with a hard squeezed cloth. DO NOT use a thinner, benzene or other organic solvent.

- **DO NOT throw away metals, combustibles or other contaminant into the opening of this equipment.**

A fire or an electric shock will be caused.

- **DO NOT put your finger or hand on the movable part or opening of the equipment.**

Otherwise, you may get injured.

- **When using the actuator in other than the horizontal state, select the vertical actuator.**

This actuator (belt-driven) cannot be used for the vertical application.

**⚠ WARNING**

- **As the equipment is heavy, make sure of its weight and gravity center position and disconnect the cables when carrying the equipment.**  
Also, DO NOT carry the equipment with the slider. Otherwise, the slider will move and you will get injured.
- **DO NOT use this equipment for the living body as a massaging machine.**  
Otherwise, you will be injured due to incorrect teaching or mis-operation.
- **This equipment has not a sealed structure. During use, grease or wear of the belt may scatter from the opening of the equipment.**  
When using this equipment for food and chemical applications, take appropriate measures against entry of them.
- **Enter the robot type and initialize the memory correctly.**  
Otherwise, the robot may move unexpectedly and you will be injured.
- **DO NOT use this equipment in an atmosphere of inflammable gas or an atmosphere inducing an explosion.**  
As this equipment is not explosion-proof, it may explode in the worst occasion.
- **DO NOT damage, break, process, forcibly bend, stretch, place a heavy object on or pinch the cables (power cable, controller cable).**  
Otherwise, an electric shock or a fire will be caused.
- **Should an abnormality such as smoke or nasty smell occur, turn the power off immediately and stop using the equipment.**  
If the equipment is used continuously, an electric shock or a fire will be caused.

**⚠ CAUTION**

- **DO NOT place the equipment at a place where the ambient temperature exceeds 40°C, or where the temperature changes sharply, causing condensing, or where it is exposed to direct sunlight.**

Additionally, if the equipment is installed at a narrow place, the ambient temperature rises due to heat generation in the controller itself or external device, which will result in malfunction or mis-operation of the equipment.

- **DO NOT use the equipment at a place where an impact or vibration is involved. Also, DO NOT use the equipment in an atmosphere where conductive dust, corrosive gas or oil mist generates.**

Otherwise, a fire, electric shock, malfunction or mis-operation will be caused.

- **DO NOT use the equipment at a place where too much dust or dirt exists.**

If the equipment is used at such a place, it may malfunction because this equipment is not dust-proof.

- **DO NOT use repair parts other than those designated by the manufacturer.**

Otherwise, the equipment cannot be operated to its full capacity and will cause malfunction.

- **Mount the robot on a highly rigid frame.**

If rigidity of the frame is not enough, vibration (or resonance) may be caused during the robot operation, adversely affecting the operation.

- **In the case of power failure, this equipment becomes a free running state. If there is a risk of work damage, use an axis that supports specifications with brakes.**

This machine does not have a dynamic brake function.  
The "BE" belt driven axis does not support specifications with brakes.

- **Do not apply force to the slider that exceeds the maximum speed of this machine.**

It may cause a malfunction.

- **Do not connect or disconnect a connector with the controller turned ON.**

Malfunction may be caused.

- **Take safety measures against fall and scatter of a work piece.**

If collision occurs, the axis decelerates suddenly and a work piece may fall and scatter.

- **Perform risk assessment for entire equipment and take required protective measures.**

- **When discarding this product, dispose correctly as an industrial waste.**

## ■ 1.2 For your safe operation

When you use the COMPO ARM BE Series, be sure to take the measures in conformity to the following instruction: This machine is an industrial robot in conformance to the provisions of Paragraph 31 of Article 36 of the Ordinance on Industrial Safety and Hygiene. Necessary cautions are specified in the "Selection", "Installation", "Use", "Periodic Inspection, etc." and "Education" of the "Technical Guideline on Safety Standards for Use of Industrial Robot" conforming to the Article 28 of the Industrial Safety and Health Law. You are requested to read them carefully and to observe the instructions. The following introduces some of them.

### ■ 1.2.1 Safety measures

(1) A safety barrier shall be provided to ensure that any person cannot enter the working area of a robot.

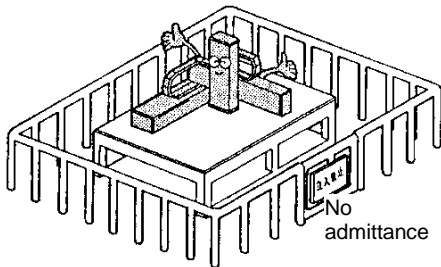

1. The barrier shall have sufficient strength to withstand the force generated during the work or environmental conditions. The barrier shall have such a structure that cannot be easily adjusted, removed or cleared.
2. The safety barrier shall be free from any serrated or sharp edge or protrusions.
3. The safety barrier shall be designed in a stationary structure.
4. When a safety barrier is equipped with a door, an interlock shall be provided so that the robot will be stopped by opening of the door.

(2) An emergency stop device shall be installed where the robot can be easily stopped by the operator immediately in the event of emergency.

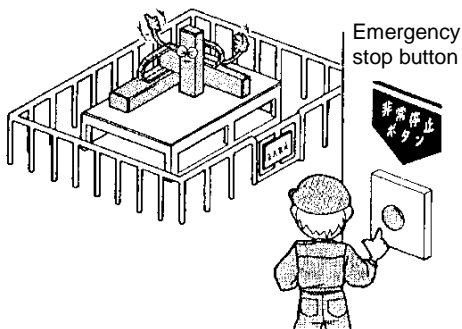

1. The emergency stop function shall ensure immediate and reliable stop of a robot when the emergency stop button switch has been operated by an operator.
2. The emergency stop button shall be red.
3. The emergency stop device shall be located so that it can be easily pulled, pressed or touched by the operator, and it can block a beam of light.
4. The emergency stop button shall be structured in such a way that it is not automatically reset after having been operated, and cannot be reset carelessly.

(3) For safety, never modify the robot main unit or control device.



## ■ 1.2.2 Precautions for installation

Observe the following instructions when installing a robot:

- (1) The robot shall be laid out to ensure the work space required for robot teaching, maintenance and inspection.
- (2) The robot controller, other controllers and stationary operation panel shall be installed outside the movable range and where the operator can watch the robot operations.
- (3) The pressure gauge, hydraulic pressure gauge and other instruments shall be installed in clearly visible positions.
- (4) The electric wiring and hydraulic/pneumatic piping shall be provided with protective covers if they may be damaged.
- (5) To ensure effective operation of the emergency stop device in the event of emergency, emergency stop device switches shall be installed on locations other than the operation panel, as required.

## ■ 1.2.3 Precautions for use

Observe the following instructions when using a robot:

[Work within the movable range]

- (1) Work provisions
  - Determine provisions for the following items and perform the work in conformity to them:
    1. Root operation methods and procedures required in the work such as startup method and switch handling method.
    2. Speed of robot main unit in teaching.
    3. Signaling method for work adjustment among more than one operator.
    4. Action to be taken by the operator for each problem.
    5. Procedures for confirming the release of the emergency and safety when restarting the robot operation after the robot operation has been stopped due to the operation of the emergency stop device.
    6. Measures to protect against the hazard due to unexpected operation of the robot described below (in addition to the above items), or the hazard caused by a robot operation error.
      - Indication on the operation panel.
      - Measures to ensure safety of the operator working within the movable range.
      - Working position and posture.
      - Prevention of operation error due to noise.
      - Signaling method for work adjustment with operators of related devices.
      - Error type and evaluation procedure.
    7. The work provisions shall meet the requirements of the robot type, installation site and work.
    8. The work provisions shall be prepared by consultation with the related operators, manufacturer's engineers and industrial safety consultant.
- (2) Indication on the operation panel
  - To ensure that the start switch and selector switch will not be carelessly operated by a person other than the personnel in charge of this work, the switch shall be provided with an easy-to-read indication to show that the work is in progress. Alternatively, the operation panel cover shall be provided with locking or other means.

- (3) Measures to ensure the operation safety of the personnel working within the movable range  
 Any one of the following measures or other measures on the equal or higher level shall be taken so that you can stop the robot operation immediately in the event of an error when working within the movable range:
1. An adequately authorized supervisor shall be assigned outside the movable range and where the robot operations can be observed. This supervisor shall be exclusively in charge of the supervision and shall be responsible for the following:
    - The supervisor shall cause the emergency stop device to be operated immediately in the event of an error.
    - The supervisor shall ensure that a person other than the personnel in charge of this work is kept outside the movable range.
  2. The emergency stop device switch shall be placed under the control of the person working within the movable range.
  3. A portable operation panel having a structure capable of on/off operation of the power source, oil hydraulic or pneumatic source shall be used in the work.
- (4) Inspection prior to start of the work such as teaching  
 Prior to start of the work such as teaching, the following items shall be inspected. If any error is detected, immediately repair the trouble or take other required action.
1. Check if the covering or sheathing of the external power source is damaged or not. (This check must be made after the power has been turned off).
  2. Check if the operation of the robot proper is faulty.
  3. Check for the functions of the braking device and emergency stop device.
  4. Check if there is any leakage of air or oil from the piping.
- (5) Cleaning of working tools  
 When such working tools as a painting nozzle are mounted on the robot proper, and these working tools must be cleaned, it is preferred that these tools should be automatically cleaned so that the number of machines entering the movable range can be minimized.
- (6) Release of residual pressure  
 Before disassembling the pneumatic components or replacing their parts, release the residual pressure in the drive cylinder.
- (7) Operation check  
 Perform the verification operation without entering the movable range, wherever possible.
- (8) Illuminance  
 The illuminance required for operation safety shall be maintained.

[For automatic operation]

- (1) Action before startup  
 Before starting the robot, check for the following items in advance and determine a signaling method for work adjustment among related operators.
1. Make sure that there is no person within the movable range.
  2. The movable operation panel and tools shall be located at specified positions.
  3. There shall be no error indication for the robot or related devices.
- (2) Action for automatic operation and in the event of an error
1. Make sure that there is an indication to show that the automatic operation is now in progress, after the robot has been started.
  2. When a problem has occurred to the robot or related device and you have to enter the movable range to take emergency measures, stop the robot operation, for example, by operating the emergency stop device before entering the movable range. At the same time, carry a safety plug with you, and ensure that the start switch is provided with the indication to show that the work is now in progress. Take measures so that any other person than the operator in charge of the emergency measures cannot operate the robot.

### Requesting your cooperation

For the safety instructions which seem especially important, relevant warning label is attached to the equipment.

When the label attached to the equipment has peeled off or the characters are defaced and unreadable, please procure it from our sales agent in your territory by specifying the part number, and attach it to the original place.

Warning label for actuator

Part number: 55620157



### **WARNING**

- Before the installation, programming, operation, maintenance and inspection of the equipment, be sure to read through this manual so that you can use the COMPO ARM with safety.
- Install the safety fences to prevent anyone from entering the working envelope of the robot.
- DO NOT put your finger or hand on the movable part or opening of the equipment. Otherwise, you may get injured.
- When using the actuator in other than the horizontal state, be sure to select the actuator with brake. Otherwise, the slider will drop at power OFF, and you will be injured.

## ■ 1.3 Warranty

### ■ 1.3.1 Warranty period

This product is warranted for one of the following periods whichever comes first.

- (1) For 24 months after shipment from our factory.
- (2) For 18 months after installation at the customer's factory.
- (3) For 4000 hours of operation.

### ■ 1.3.2 Details of warranty

- (1) This product is warranted. The scope of the warrant includes the specifications and functions described in the Specification, catalog and Instruction Manual. We are not responsible for any secondary or incidental damages caused by the trouble of this product.
- (2) We will repair, on a free-of-charge basis, the trouble caused in the handling or use of the product within the warranty period of this product as described in the Instruction Manual attached to this product. Alternatively, such trouble will be repaired after the product has been returned to our factory. If the problem is solved by a dispatch of service personnel to meet the convenience of the customer, we may claim payment from your company regarding the transportation expenses, lodging expenses or other expenditures not directly related to the repair of the product.

### ■ 1.3.3 Exemption from responsibility

The following cases shall be excluded from the scope of warrant.

- (1) The trouble and damage caused by the use of the product according to a method not described in the Instruction Manual, or by a careless error in use.
- (2) Problems caused by chronological changes or wear by use (such as natural fading of paints, deterioration of the consumable parts \*1).
- (3) Problems caused by sensory phenomena (e.g. generated noise without affecting the function).
- (4) Modification or disassembling not authorized by our company.
- (5) Troubles or damages caused by inadequate maintenance and inspection or improper repair.
- (6) Troubles or damages caused by natural disaster, fire and other external factors.
- (7) Internal data such as programs and points created or modified by the customer.
- (8) Problems caused when this product purchased in Japan is brought to an overseas country.

\*1 : Consumable parts are defined as the parts maintenance replacement parts (spare parts) described in the Instruction Manual of each product, and the parts (e.g. backup battery) that must be replaced on a periodic basis.

### ■ 1.3.4 Precautions

- (1) When you have used the product beyond the specifications of the product, we cannot warrant the basic performances of the product.
- (2) Should you fail to observe the instructions given in "WARNING" and "CAUTION" described in the Instruction Manual, we are not responsible for any personal injury, damages or trouble that may occur.
- (3) Please note that the "WARNING" and "CAUTION" described in the Instruction Manual, and other descriptions are within the scope assumed by our company.
- (4) The numerical values given as technical data are theoretical values as a guideline showing the durability and others. They shall not be construed as indicating warranty. Note that these values are subject to change according to the conditions of use.

## Chapter 2 Shipment List

### ■ 2.1 Shipment list

When the axis proper is shipped, it is composed of the following parts:

- (1) Actuator (axis)
- (2) Number of oval bolts attached (M6×30)
  - The above-mentioned axis-1 will be provided with the bolts in the number shown in the right-hand Table.



Axis stroke (mm)	Attached quantity
100~200	12
250~600	16
650~1000	20
1050~1300	26
1350~1850	32

- (3) Introduction Manual

# Chapter 3 Axis Specifications

## 3.1 Axis type and names of individual parts

### ■ Type of axis

The following shows the axis type:

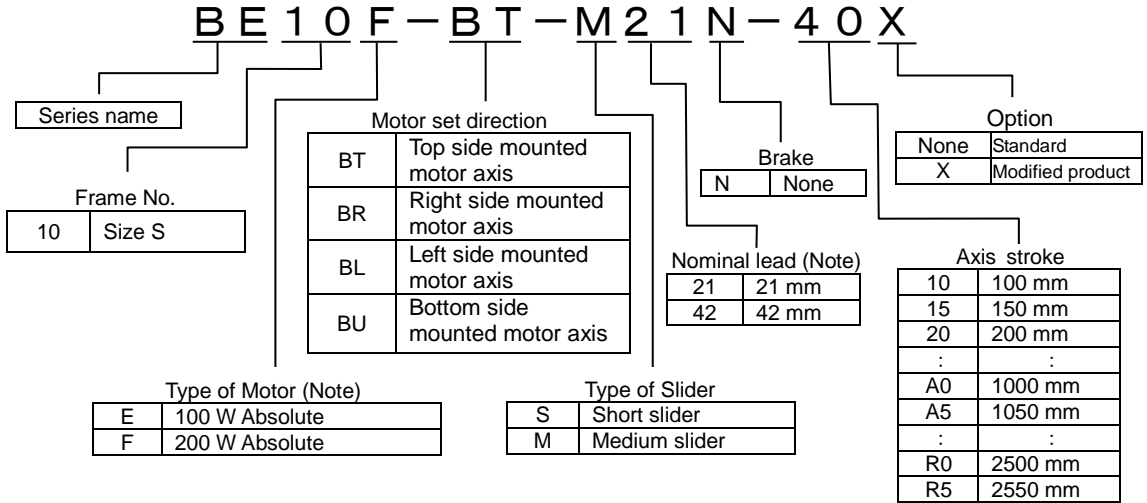

Note 1: Compatible only with the 21 mm-lead product in the case of a 100-watt motor

### ■ Names of individual parts

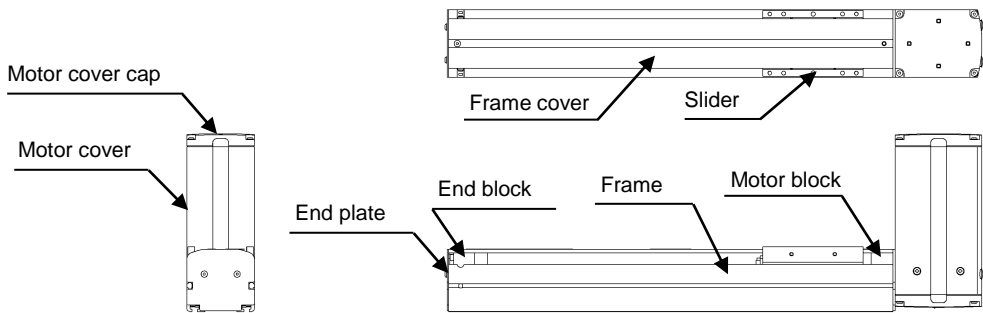

## 3.2 Single axis specification

### Specifications

Type of axis BE10□-B□-□□□N-□□

The values enclosed in parentheses indicate those for the AC 200-watt servo motor.

Motor		AC 100-watt servo motor absolute) (AC 200-watt servo motor absolute)
Drive method		Timing belt    Lead 21 mm Lead 42 mm
Guide method		Linear guide (single) Short slider ..... bearing block ... 1 piece Intermediate slider..... bearing block ... 2 pieces
Maximum payload mass (Note 1) (Note 3)	Lead	Horizontal
	21 mm	15(20) kg
	42 mm (Note 2)	(10) kg
Maximum speed (Note 1) (Note 2)	Lead 21 mm	1000 mm/s
	Lead 42 mm	2000 mm/s
Static permissible moment (Note 4)	Short slider	MR:49 Nm    MP:14 Nm    MY:13 Nm
	Medium slider	MR:59 Nm    MP:59 Nm    MY:54 Nm
Repeated positioning accuracy (Note 5)		±0.04 mm
Resolution		0.01 mm
Rated thrust	Lead 21 mm	95(190) N
	Lead 42 mm	(95) N

(Note 1) The part with a lead of 21 mm has an acceleration/deceleration time of 0.3 s or more.  
The part with a lead of 42 mm has an acceleration/deceleration time of 0.5 s or more.

(Note 2) The part with a lead of 42 mm is compatible only with a 200-watt motor.

### CAUTION

Set the part with a lead of 21 mm to an acceleration/deceleration time below 0.3 s.  
Set the part with a lead of 42 mm to an acceleration/deceleration time below 0.5 s.  
A misalignment may occur in meshing between the timing belt and pulley

(Note 3) Set the pause time after movement to 1.0 sec or longer.

(Note 4)

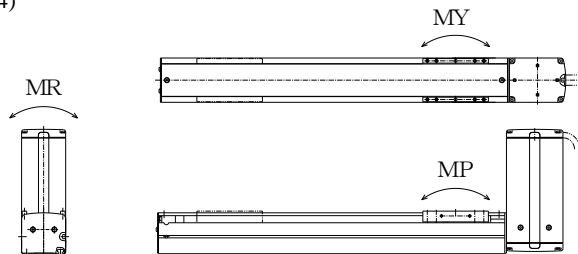

MR: Rolling Moment  
MP: Pitching Moment  
MY: Yawing Moment

(Note 5) Repeatability in one direction during 7 trials at a constant ambient temperature of 20°C. It is not absolute positioning accuracy. Trajectory accuracy is not guaranteed.

■ Axis dimensions

(1) Top side mounted motor axis [BE10\*-BT-\*\*\*N]

Type	10	20	30	40	50	60	70	80	90	A0	B0	C0	D0	E0	F0	G0	H0	J0	K0	L0	M0	N0	P0	Q0	R0	
BE10E-BT-M21N-□□																										
BE10F-BT-M21N-□□																										
BE10F-BT-M42N-□□																										
Stroke X (mm)	100	200	300	400	500	600	700	800	900	1000	1100	1200	1300	1400	1500	1600	1700	1800	1900	2000	2100	2200	2300	2400	2500	
Full length L (mm)	419.7	519.7	619.7	719.7	819.7	919.7	1019.7	1119.7	1219.7	1319.7	1419.7	1519.7	1619.7	1719.7	1819.7	1919.7	2019.7	2119.7	2219.7	2319.7	2419.7	2519.7	2619.7	2719.7	2819.7	
Weight (kg)	B10E Lead 21	4.9	5.6	6.2	6.9	7.6	8.2	8.9	9.6	10.2	10.9	12.1	12.8	13.5	14.2	14.9	15.6	16.3	17.0	17.8	18.5	19.2	19.9	20.6	21.3	22.0
	B10F Lead 42																									
	BE10F Lead 21	5.5	6.2	6.8	7.5	8.2	8.8	9.5	10.2	10.8	11.5	12.7	13.4	14.1	14.8	15.5	16.2	16.9	17.6	18.4	19.1	19.8	20.5	21.2	21.9	22.6
Type	15	25	35	45	55	65	75	85	95	A5	B5	C5	D5	E5	F5	G5	H5	J5	K5	L5	M5	N5	P5	Q5	R5	
BE10E-BT-M21N-□□																										
BE10F-BT-M21N-□□																										
BE10F-BT-M42N-□□																										
Stroke X (mm)	150	250	350	450	550	650	750	850	950	1050	1150	1250	1350	1450	1550	1650	1750	1850	1950	2050	2150	2250	2350	2450	2550	
Full length L (mm)	419.7	519.7	619.7	719.7	819.7	919.7	1019.7	1119.7	1219.7	1319.7	1419.7	1519.7	1619.7	1719.7	1819.7	1919.7	2019.7	2119.7	2219.7	2319.7	2419.7	2519.7	2619.7	2719.7	2819.7	
Weight (kg)	B10E Lead 21	4.5	5.2	5.9	6.5	7.2	7.9	8.5	9.2	9.8	10.5	11.7	12.4	13.1	13.8	14.5	15.2	15.9	16.6	17.3	18.0	18.7	19.4	20.1	20.8	21.5
	B10F Lead 42																									
	BE10F Lead 21	5.1	5.8	6.5	7.1	7.8	8.5	9.1	9.8	10.4	11.1	12.3	13.0	13.7	14.4	15.1	15.8	16.5	17.2	17.9	18.6	19.3	20.0	20.7	21.4	22.1

[NOTE] The format of the table lists only the end of the symbol "□□" part of the type.

The values in parentheses are applicable when the stroke is 1100mm or over.

[BE10\*-BT-M\*\*N]

[BE10\*-BT-S\*\*N]

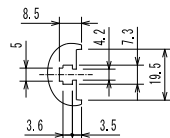
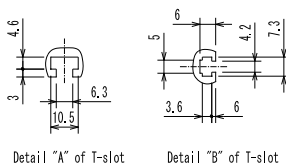

Detail "C" of T-slot

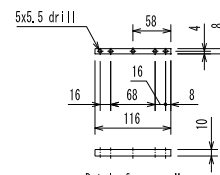
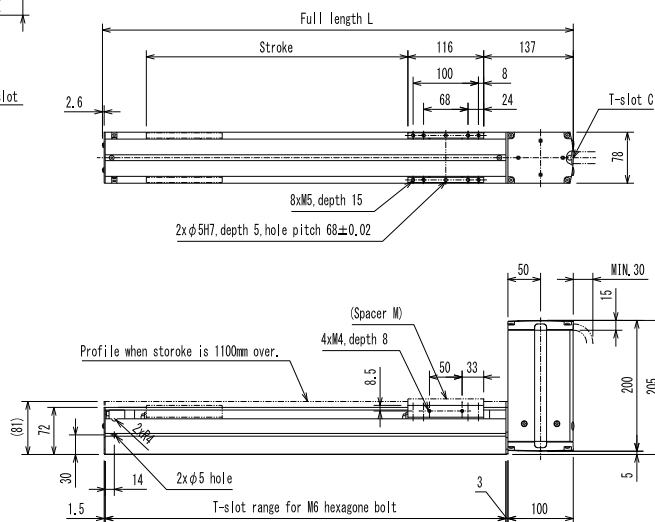
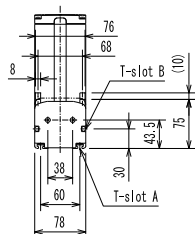

Detail of spacer M

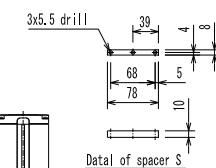

Detail of spacer S

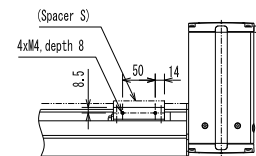
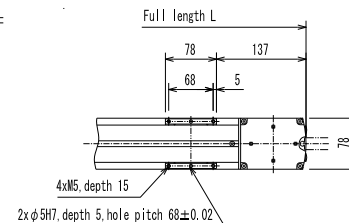

[NOTE] The values in parentheses are applicable when the stroke is 1000mm or over.



(2) Bottom side mounted motor axis [BE10\*-BU-\*\*\*N]

Type		Type																								
BE10E-BU-M21N-□□		10	20	30	40	50	60	70	80	90	A0	B0	C0	D0	E0	F0	G0	H0	J0	K0	L0	M0	N0	P0	Q0	R0
BE10F-BU-M21N-□□																										
BE10F-BU-M42N-□□																										
Stroke X (mm)		100	200	300	400	500	600	700	800	900	1000	1100	1200	1300	1400	1500	1600	1700	1800	1900	2000	2100	2200	2300	2400	2500
Full length L (mm)		419.7	519.7	619.7	719.7	819.7	919.7	1019.7	1119.7	1219.7	1319.7	1419.7	1519.7	1619.7	1719.7	1819.7	1919.7	2019.7	2119.7	2219.7	2319.7	2419.7	2519.7	2619.7	2719.7	2819.7
Weight (kg)	B10E Lead 21	4.9	5.6	6.2	6.9	7.6	8.2	8.9	9.6	10.2	10.9	12.1	12.8	13.5	14.2	14.9	15.6	16.3	17.0	17.8	18.5	19.2	19.9	20.6	21.3	22.0
	B10F Lead 42																									
	BE10F Lead 21	5.5	6.2	6.8	7.5	8.2	8.8	9.5	10.2	10.8	11.5	12.7	13.4	14.1	14.8	15.5	16.2	16.9	17.6	18.4	19.1	19.8	20.5	21.2	21.9	22.6
Type		Type																								
BE10E-BU-M21N-□□		15	25	35	45	55	65	75	85	95	A5	B5	C5	D5	E5	F5	G5	H5	J5	K5	L5	M5	N5	P5	Q5	R5
BE10F-BU-M21N-□□																										
BE10F-BU-M42N-□□																										
Stroke X (mm)		150	250	350	450	550	650	750	850	950	1050	1150	1250	1350	1450	1550	1650	1750	1850	1950	2050	2150	2250	2350	2450	2550
Full length L (mm)		419.7	519.7	619.7	719.7	819.7	919.7	1019.7	1119.7	1219.7	1319.7	1419.7	1519.7	1619.7	1719.7	1819.7	1919.7	2019.7	2119.7	2219.7	2319.7	2419.7	2519.7	2619.7	2719.7	2819.7
Weight (kg)	B10E Lead 21	4.5	5.2	5.9	6.5	7.2	7.9	8.5	9.2	9.8	10.5	11.7	12.4	13.1	13.8	14.5	15.2	15.9	16.6	17.3	18.0	18.7	19.4	20.1	20.8	21.5
	B10F Lead 42																									
	BE10F Lead 21	5.1	5.8	6.5	7.1	7.8	8.5	9.1	9.8	10.4	11.1	12.3	13.0	13.7	14.4	15.1	15.8	16.5	17.2	17.9	18.6	19.3	20.0	20.7	21.4	22.1

[NOTE] The format of the table lists only the end of the symbol "□□" part of the type.

The values in parentheses are applicable when the stroke is 1100mm or over.

14

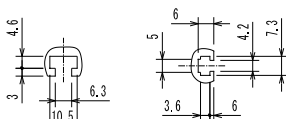

Detail "A" of T-slot      Detail "B" of T-slot

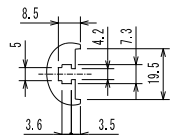

Detail "C" of T-slot

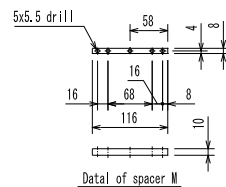
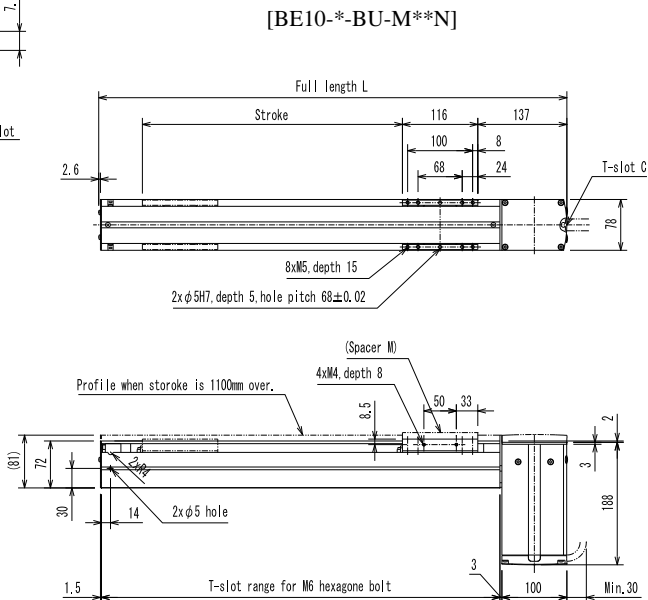
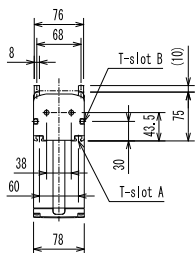

Data of spacer M

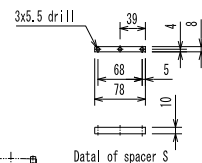

Data of spacer S

[BE10\*-BU-S\*\*\*N]

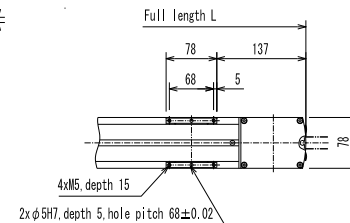

[NOTE] The values in parentheses are applicable when the stroke is 1000mm or over.

(3) Right side mounted motor axis [BE10\*-BR-\*\*\*N]

Type		Type																								
BE10E-BR-M21N-□□		10	20	30	40	50	60	70	80	90	A0	B0	C0	D0	E0	F0	G0	H0	J0	K0	L0	M0	N0	P0	Q0	R0
BE10F-BR-M21N-□□																										
BE10F-BR-M42N-□□																										
Stroke X (mm)		100	200	300	400	500	600	700	800	900	1000	1100	1200	1300	1400	1500	1600	1700	1800	1900	2000	2100	2200	2300	2400	2500
Full length L (mm)		419.7	519.7	619.7	719.7	819.7	919.7	1019.7	1119.7	1219.7	1319.7	1419.7	1519.7	1619.7	1719.7	1819.7	1919.7	2019.7	2119.7	2219.7	2319.7	2419.7	2519.7	2619.7	2719.7	2819.7
Weight (kg)	B10E Lead 21	4.9	5.6	6.2	6.9	7.6	8.2	8.9	9.6	10.2	10.9	12.1	12.8	13.5	14.2	14.9	15.6	16.3	17.0	17.8	18.5	19.2	19.9	20.6	21.3	22.0
	B10F Lead 42																									
	BE10F Lead 21	5.5	6.2	6.8	7.5	8.2	8.8	9.5	10.2	10.8	11.5	12.7	13.4	14.1	14.8	15.5	16.2	16.9	17.6	18.4	19.1	19.8	20.5	21.2	21.9	22.6
Type		Type																								
BE10E-BR-M21N-□□		15	25	35	45	55	65	75	85	95	A5	B5	C5	D5	E5	F5	G5	H5	J5	K5	L5	M5	N5	P5	Q5	R5
BE10F-BR-M21N-□□																										
BE10F-BR-M42N-□□																										
Stroke X (mm)		150	250	350	450	550	650	750	850	950	1050	1150	1250	1350	1450	1550	1650	1750	1850	1950	2050	2150	2250	2350	2450	2550
Full length L (mm)		419.7	519.7	619.7	719.7	819.7	919.7	1019.7	1119.7	1219.7	1319.7	1419.7	1519.7	1619.7	1719.7	1819.7	1919.7	2019.7	2119.7	2219.7	2319.7	2419.7	2519.7	2619.7	2719.7	2819.7
Weight (kg)	B10E Lead 21	4.5	5.2	5.9	6.5	7.2	7.9	8.5	9.2	9.8	10.5	11.7	12.4	13.1	13.8	14.5	15.2	15.9	16.6	17.3	18.0	18.7	19.4	20.1	20.8	21.5
	B10F Lead 42																									
	BE10F Lead 21	5.1	5.8	6.5	7.1	7.8	8.5	9.1	9.8	10.4	11.1	12.3	13.0	13.7	14.4	15.1	15.8	16.5	17.2	17.9	18.6	19.3	20.0	20.7	21.4	22.1

[NOTE] The format of the table lists only the end of the symbol "□□" part of the type.

The values in parentheses are applicable when the stroke is 1100mm or over.

15

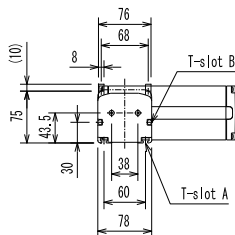
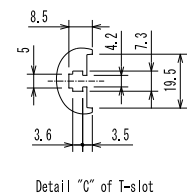
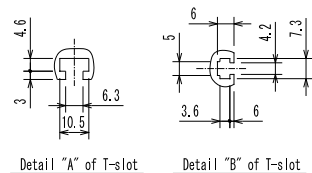

[BE10\*-BR-M\*\*N]

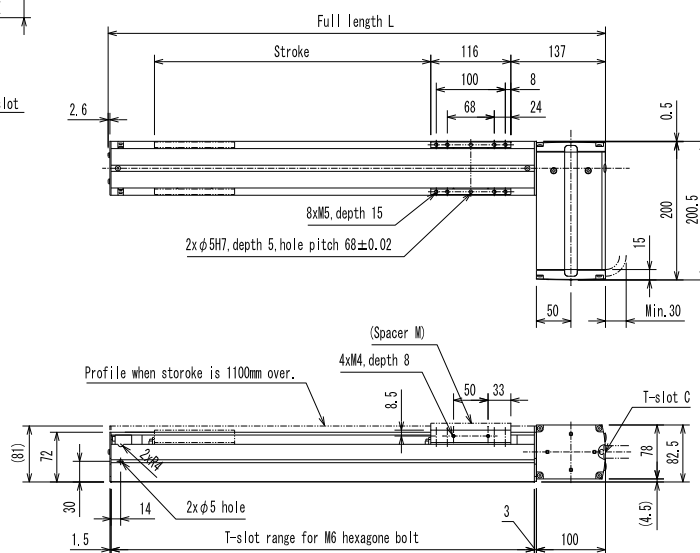

[BE10\*-BR-S\*\*N]

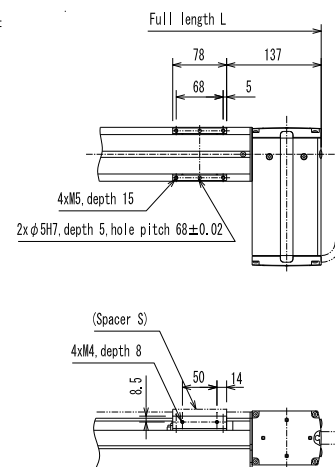
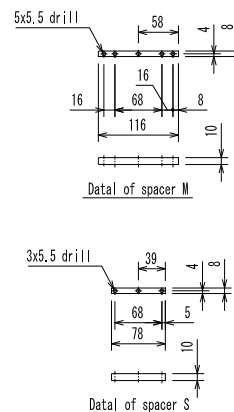

[NOTE] The values in parentheses are applicable when the stroke is 1000mm or over.

(4) Left side mounted motor axis [BE10\*-BL-\*\*\*N]

Type		10	20	30	40	50	60	70	80	90	A0	B0	C0	D0	E0	F0	G0	H0	J0	K0	L0	M0	N0	P0	Q0	R0	
BE10E-BL-M21N-□□																											
BE10F-BL-M21N-□□																											
BE10F-BL-M42N-□□																											
Stroke X (mm)		100	200	300	400	500	600	700	800	900	1000	1100	1200	1300	1400	1500	1600	1700	1800	1900	2000	2100	2200	2300	2400	2500	
Full length L(mm)		419.7	519.7	619.7	719.7	819.7	919.7	1019.7	1119.7	1219.7	1319.7	1419.7	1519.7	1619.7	1719.7	1819.7	1919.7	2019.7	2119.7	2219.7	2319.7	2419.7	2519.7	2619.7	2719.7	2819.7	
Weight (kg)	B10E Lead 21	4.9	5.6	6.2	6.9	7.6	8.2	8.9	9.6	10.2	10.9	12.1	12.8	13.5	14.2	14.9	15.6	16.3	17.0	17.8	18.5	19.2	19.9	20.6	21.3	22.0	
	B10F Lead 42																										
	BE10F Lead 21	5.5	6.2	6.8	7.5	8.2	8.8	9.5	10.2	10.8	11.5	12.7	13.4	14.1	14.8	15.5	16.2	16.9	17.6	18.4	19.1	19.8	20.5	21.2	21.9	22.6	
Type		15	25	35	45	55	65	75	85	95	A5	B5	C5	D5	E5	F5	G5	H5	J5	K5	L5	M5	N5	P5	Q5	R5	
BE10E-BL-M21N-□□																											
BE10F-BL-M21N-□□																											
BE10F-BL-M42N-□□																											
Stroke X (mm)		150	250	350	450	550	650	750	850	950	1050	1150	1250	1350	1450	1550	1650	1750	1850	1950	2050	2150	2250	2350	2450	2550	
Full length L(mm)		419.7	519.7	619.7	719.7	819.7	919.7	1019.7	1119.7	1219.7	1319.7	1419.7	1519.7	1619.7	1719.7	1819.7	1919.7	2019.7	2119.7	2219.7	2319.7	2419.7	2519.7	2619.7	2719.7	2819.7	
Weight (kg)	B10E Lead 21	4.5	5.2	5.9	6.5	7.2	7.9	8.5	9.2	9.8	10.5	11.7	12.4	13.1	13.8	14.5	15.2	15.9	16.6	17.3	18.0	18.7	19.4	20.1	20.8	21.5	
	B10F Lead 42																										
	BE10F Lead 21	5.1	5.8	6.5	7.1	7.8	8.5	9.1	9.8	10.4	11.1	12.3	13.0	13.7	14.4	15.1	15.8	16.5	17.2	17.9	18.6	19.3	20.0	20.7	21.4	22.1	

[NOTE] The format of the table lists only the end of the symbol "□□" part of the type.

The values in parentheses are applicable when the stroke is 1100mm or over.

[BE10\*-BL-M\*\*\*N]

[BE10\*-BL-S\*\*\*N]

16

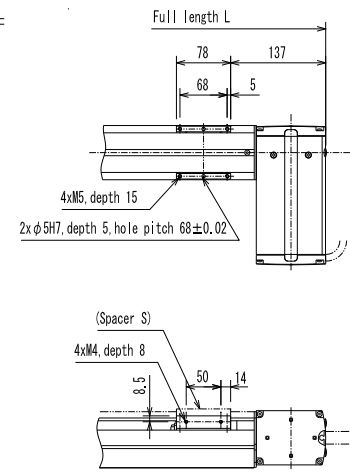
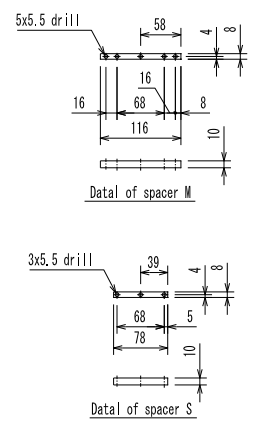
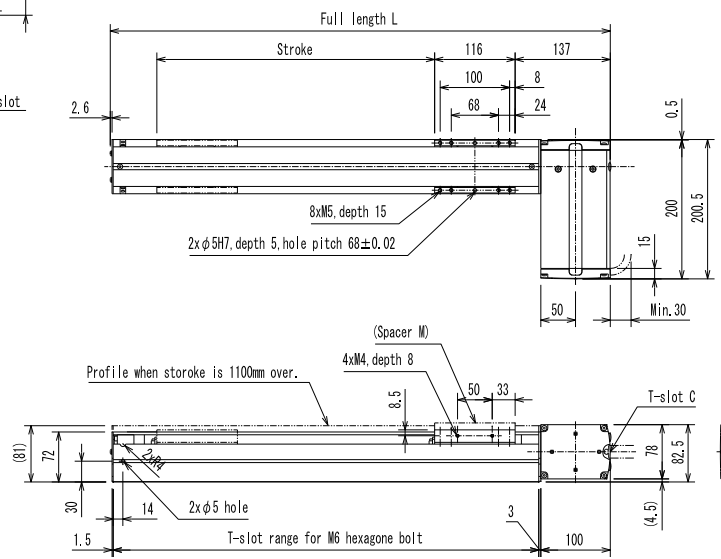
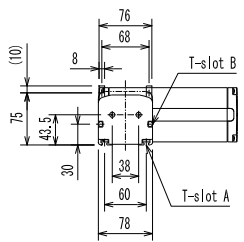
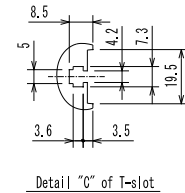
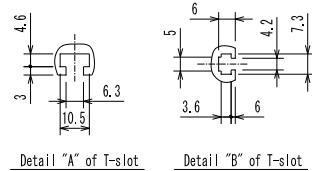

[NOTE] The values in parentheses are applicable when the stroke is 1000mm or over.

## Chapter 4 Cable Installation

Install the cable according to the following procedure:

- (1) Loosen the four hexagon socket head button bolts holding the motor cover cap and remove the motor cover cap from the motor cover.

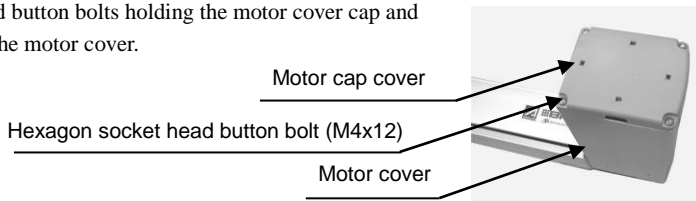

- (2) Select the cover of the cable outlet in the direction where the cable of the motor cover cap is pulled out, and hold it with cutting pliers. Then remove it by twisting.

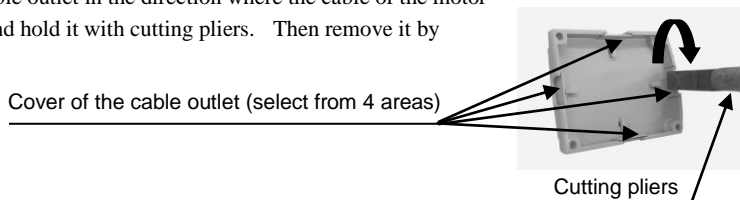

- (3) Insert a band into the lateral hole on the portion without the cover of the cable outlet of the motor cover cap.

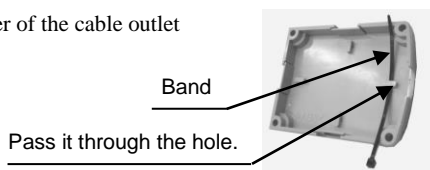

- (4) Use the band to fix the side of the controller cable which is fitted to the axis.  
Do not tighten the band excessively.  
Do not insert the cable excessively.

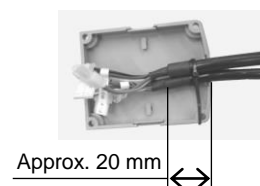

- (5) Insert the connector for the axis side of the controller cable into the connector for the axis body (for motor power, encoder, origin sensor) until it is locked, and connect it securely.

(This machine does not have a brake except for special specifications, so it is not necessary to connect the brake connector. If it is a special specification with a brake, connect it.)

Reattach the motor cover cap to the motor cover.

Insert the motor power connector for the controller side of the cable into the connector on the surface of the controller until it is locked, and then connect it securely. Insert the encoder connector into the connector on the surface of the controller and fix it with screws.

For the connector on the controller side, also refer to the CA25 Instruction Manual (Basic part).



### ⚠ CAUTION

- Before energizing, be sure to check that there are no connector connection leaks or connection errors.
- Do not pinch the wiring between the motor cover cap and the motor cover.
- When connecting or fixing the connector, do not apply excessive force to the cable.

## Chapter 5 Installing Actuator (Axis)

- This chapter describes the basic installation procedures for the axis and peripheral equipment.
- Installation shall comply with the instructions of this Chapter. If the installation procedure is incorrect, robot performance cannot be achieved. Not only that, the service life may be seriously reduced.



### CAUTION

Precautions for installation

#### ● Environment of installation site

(1) The ambient environment for operation shall comply with the following requirements:

- Ambient temperature      Working temperature: 0°C to 40°C  
   Transportation and storage temperature: -10°C to 50°C
- Relative humidity:      30 to 90%RH without dew condensation
- Altitude:                    1000 m or less
- Vibration                    0.98 m/s<sup>2</sup> or less
- Dust:                         Free from conductive dust or dirt
- Gas:                         Free from flammable or corrosive gas
- Magnetic field:            Free from a nearby device that may generate magnetic field
- Radiation:                 Not in the radiation controlled area
- Others:                      Without greasy fume

(2) This product is not designed as an explosion proof structure. Do not use it in a dusty place. Further, take sufficient care of the environment since it is not explosion-proof.

(3) Do not use it in a place with an organic solvent or white kerosene.  
Of guide or ball screw grease is melted. It may cause malfunction.

#### ● Precautions in installation

(1) Do not allow the product to fall down or be collided with other object during the transportation.

(2) Install the product where maintenance and inspection are easier.

(3) Install the controller within the range where it can be reached from the robot proper by a standard cable.

(4) Installation

- Install the product on a horizontal installation base.
- The installation base shall have the length that allows only the frame portion to be mounted.
- The installation base shall be made of a steel plate having a thickness of 9 mm or more where the plate has a machined surface with flatness of 0.2 or less. Install this product on this base to correct the bend and twist of the axis frame and to reinforce the axis frame.
- Install the oval bolts (installation bolts) of the axis at a pitch of approximately 150 mm.

## ■ 5.1 Installing Actuator (Axis)

Installation shall comply with the following procedures:

(1) Setting the oval bolt

From the axis end face, insert the oval bolt in the T-slots of the frame installation surface.

(2) Mounting on the installation base

Drill installation holes on the installation base of the carriage at a pitch of approximately 150 mm, and mount the product with oval bolts.

### CAUTION

- The T-slots (for M4 nut) on the side and top of the frame are used to install the CN box and optical parts. Never use these T-slots to mount the axis.
- The nut (M6) tightening torque shall be 5.3 N-m.

## ■ 5.2 Robot type for each Axis

The robot type is indicated by the 6-digit numerals specified for each robot type.

If this setting is made, various parameter values suited to the axis to be used can be automatically set. The input procedure is given in Section 4.2 of the CA25 Instruction Manual (Basic Part).

The major robot type for each axis is given in the following Table. The axis (new models) not described in the following Table are specified in the Actuator Instruction Manual.

When you want to use a combination of axes, see the following Table for each an axis.

[Robot type for BE10]

- When used as a slider traveling type axis (in normal use)

	Lead (mm)	Type of axis	Robot type
BE10E	21	BE10E-B□-□21□-□□	601090
BE10F	21	BE10F-B□-□21□-□□	602290
	42	BE10F-B□-□42□-□□	602280



- When you have used the origin change sensor (optional) and set the home position to the side reverse to the normal side, input the robot type prior to change. After that, change the "Setting the motor rotating direction" in paragraph 2 of Section 13.4.5 described in the CA25 Instruction Manual (Basic Part) (Change it from 1 to 0).

## ■ 5.3 Parameter values

The parameters of this product are available in two types -- parameter 1 and parameter 2 -- depending on the frequency of use. The relationship between each parameter and the robot type is illustrated below:

Setting the robot type allows the parameters on the circled portion on the left to be automatically changed.

### ■ 5.3.1 Values of parameter 1 for each robot type

This parameter has a higher frequency of use.

- Belt-driven axis (slider movable type)

Automatic setting	Robot type		601090	602290	602280
			(100 W, Lead 21)	(200 W, Lead 21)	(200 W, Lead 42)
	Software limit value (upper limit)		0000.00	0000.00	0000.00
	Software limit value (lower limit)		0000.00	0000.00	0000.00
○	Servo gain Position/Speed	Position	32	27	31
		Speed	35	85	50
	Pass area		0200		
	Origin offset value		0000.00	0000.00	0000.00
	Sequence of Return to Origin		1 (Note)	1 (Note)	1 (Note)
	JOG speed	L(Low speed)	010	010	010
		H(High speed)	050	050	050
	JOG inching movement		0.01	00.01	00.01

(Note) The Sequence of Return to Origin varies according to the combination format, installation conditions and others. The customer is requested to set it in conformity to your operation conditions. The initial value is common at "1" for all robot types. Thus, if there is no change, simultaneous origin return of all axes can be achieved.

#### CAUTION

Regarding the servo gain value, the initial value is automatically set by the input of the robot type, but the conditions vary depending on the specifications of the axis (stroke, grease change, etc.), the installation state of the axis, the load mounting state, etc. Since it will change, change the set value if it is necessary to shorten the cycle time or if abnormal noise is generated due to the oscillation of the servo motor. For the servo gain, please also check the section of ■ 6.4 "Servo gain setting". For details on how to change the servo gain setting, refer to Sections 13.3.3 and 13.3.4 of the CA25 Operation Manual (Basic Part).

## ■5.3.2 Values of parameter 2 for each robot type

- Belt-driven axis (slider movable type)

Automatic setting	Robot type		601090	602290	602280	
			(100 W, Lead 21)	(200 W, Lead 21)	(200 W, Lead 42)	
	Axis display		X	X	X	
	In position data value		00.05	00.05	00.05	
	Overflow data value		20000	20000	20000	
○	Feed forward data value		02000	02000	02000	
○	Direction of motor rotation		1	1	1	
○	Maximum speed		1000	1000	2000	
○	Return to origin speed	(L) Low speed	010	010	010	
		(M) Medium speed	050	050	050	
		(H) High speed	200	200	200	
○	Return to origin method		1	1	1	
○	Origin sensor logic		0	0	0	
	High speed return to origin position		0020.00	0020.00	0020.00	
○	Lead		21.015	21.015	42.000	
○	Encoder division number		2768	2768	2768	
○	Encoder pulse multiplier		4	4	4	
	Encoder type (Note)		a	a	a	
	Task and axis combination		[1]	[0]	[0]	[0]
	Task order of priority		[1]	[1]	[1]	[1]
	Task coordinate table		999	999	999	999
	Task step number		5000	0000	0000	0000

(Note) The encoder type cannot be set in this robot type since setting for each axis is not available.  
See Section 13.4.17 of the CA25 Instruction Manual (Basic Part).



## Chapter 6 Precautions for Use

### ■ 6.1 Fluctuation in sliding resistance during long-term storage

The belt drive axis of the COMPO ARM drives the slider by meshing between the timing belt and pulley.

When the COMPO ARM has been stored or its operation has been suspended for a longer period of time (\*1), the timing belt is kept curled at the meshing portion between the timing belt and pulley (or roller).

When the slider is subjected to sliding close to this curl, a fluctuation occurs to the sliding resistance, but this does not raise any problem.

This curl does not affect the timing belt. Further, the fluctuation in the sliding resistance of the slider does not have any adverse effect on the repeated positioning accuracy.

The curl of the timing belt will be removed after several days of operation (\*2). The fluctuation in the sliding resistance due to the curl of the belt will also be removed.

For the bend of the timing belt, see Section 7.8 Routing the timing belt.

\*1: About a week. This may vary according to the environment during storage.

\*2: The number of days of operation before the curl of the timing belt is removed varies according to the number of reciprocations of the slider per day and the storage period.

### ■ 6.2 In the event of collision

Skipping of teeth may occur to the meshing between the belt and pulley by the collision between the slider and axis end due to some trouble. If this occurs, the origin and working range will be misaligned.

In this case, the axis must be readjusted. Retighten the belt. For the belt tightening procedure, see Section 7.5 Timing belt and motor replacement procedure.

## ■ 6.3 About cracks on the back of the timing belt during long-term operation

When the slider part of the belt drive axis reciprocates about 1 million (\*1), crack-like streaks occur in the rubber on the back surface (toothless surface) of the timing belt. However, if you are using it within the specifications, there is no problem.

Please note that the life of the timing belt may be shortened if the number of reciprocating operations is large, such as high-speed cycle operation.

Check the timing belt regularly. If there is a problem, replace the timing belt immediately. This crack-like streaks is caused by the reciprocating motion of the timing belt hung on the pulley.

The number of crack-like streaks increases in proportion to the number of movements up to about 5 million round trips (\* 1), and crack-like streaks are generated in a narrow pitch.

(The minimum crack-like streaks pitch is about 3 mm.)

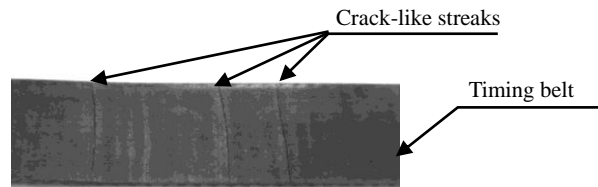

Initial crack-like streaks development (back of timing belt)  
(After about 1 million round trips)

Before the timing belt reaches the end of its life, the following signs and abnormalities of the belt life may appear.

- The rubber on the back of the timing belt has peeled off from the crack on the back of the timing belt.
  - The groove on the back of the timing belt is widened.  
(Rhagades change from streaks to grooves)
  - The tooth of the timing belt is missing.
- etc.

If you find any signs or abnormalities during the inspection before starting the work and periodic inspection, replace the timing belt as soon as possible.

For the timing belt replacement procedure, refer to ■ 7.7 “Timing belt and motor replacement procedure”.

### ▲ CAUTION

If the timing belt is used under conditions outside the specified range, it may reach the end of its life such as breakage in a short operating time before crack-like streaks appear on the belt or signs of life appear.

Be sure to use it under the load conditions within the specified range and the usage environment.

\*1: The number of reciprocating operations described is a guideline value. It varies depending on the load conditions and usage environment.

In addition, the number of reciprocating movements counts the number of reciprocating movements within the stroke range regardless of the movement stroke.

If models with different strokes make one round trip of the full stroke, both are counted as the same one round trip.

Example: Stroke 100 mm, 3 seconds / round trip and Stroke 2,000 mm, 10 seconds / round trip are counted as the same one round trip.

## ■6.4 Servo gain setting

In the actuator, in order to facilitate the parameter setting work of the controller, the initial parameters for operating the component arm are automatically set by setting the "robot type" (6 digit number) determined for each model to the controller.

The initial value of the servo gain that is automatically set is set to a value that does not cause abnormal noise or vibration in single-axis or combination operation with no load to maximum load. Therefore, the operation cycle time tends to be slower overall. Also, in the initial value state, the cycle time may be longer than that of the old model. The servo gain value is designed to be adjusted by the customer according to the operating conditions and load conditions, such as when shortening the cycle time. Please adjust the servo gain value by referring to ■5.1.1 "Servo gain setting value and operating condition".

For details on how to change the servo gain setting, refer to Sections 13.3.3 and 13.3.4 of the CA25 Operation Manual (Basic Part).

For the robot type setting value, refer to ■5.2 "Robot type for each Axis", and for the initial parameter value set by the robot type setting, refer to ■5.3 "Parameter values".

### ■6.4.1 Servo gain setting value and operating condition

The relationship between the servo gain setting value and the operating state is as follows.

#### (1) Position gain (P)

- When the set value is reduced
  - Positioning completion will be delayed (cycle time will be longer).
  - If the position gain is set too small, an error such as an "overflow error" may occur during operation (especially during acceleration) and operation may not be possible.
  - The positioning and holding force of the slider is reduced (rigidity is reduced).  
(When the servo is turned on and the slider operation is stopped (servo holding state), it becomes easier to move when an external force is applied to the slider part.)
  - In the case of elevating operation specifications, if an emergency stop is applied while the operation is stopped with the servo on, the amount of drop of the slider will increase.  
The BE belt driven axis does not support vertical specifications (specifications with brakes).
  
- When the set value is increased
  - Positioning is completed faster. (cycle time is shorter)
  - Deceleration stop becomes faster, and shaking when deceleration stop becomes larger.  
(Especially when the combination specification or when the distance from the slider to the load is long, the shaking becomes large.)
  - Immediately before deceleration stops, shaking will occur due to speed fluctuations.  
(It behaves like shaking just before it stops, especially when the load is heavy.)
  - If it is made excessively large, abnormal noise will be generated due to the oscillation of the servo motor.
  - The positioning holding force of the slider part increases. (the rigidity increases) (it becomes difficult to move even if an external force is applied to the slider part when the servo is ON and the slider operation is stopped (servo holding state).)
  - In the case of a belt drive axis, the teeth of the belt may come off due to faster deceleration, and a position error may occur. (Especially when the load is heavy, it is likely to occur)
  - By shortening the cycle time, "overload error" and abnormalities due to overheating of the motor are more likely to occur.

(2) Speed gain (V)

- When the value is reduced
  - If it is made too small, an error such as "overflow error" may occur during operation (especially when accelerating) and operation may not be possible.
  - The positioning and holding force of the slider is reduced. (Rigidity decreases)
- When the value is increased
  - Abnormal noise is generated due to the oscillation of the servo motor.  
(Depending on the installation state and load conditions, when the servo is turned on, abnormal noise may occur in the slider operation stop state (servo holding state) or operation state.)

**CAUTION**

The relationship between gain value and operation described above is an example of a general condition. Other states may appear depending on the combination state, load conditions, operating conditions, and the combination of position gain and speed gain settings.

## ■6.4.2 About adjustment of servo gain

When adjusting the servo gain, refer to the contents described in ■ 6.4.1 "Servo gain setting value and operating condition" and set according to the following description.

### (1) Speed gain setting

The initial value of speed gain usually does not need to be changed.

If it is changed, please set as follows.

By increasing the speed gain, the holding rigidity of the slider part becomes stronger, but abnormal noise is more likely to occur.

#### 1. Be sure to perform the confirmation operation.

Increase the speed gain value by 1 or 2 until abnormal noise occurs during operation or stop.

(If there is an abnormal noise such as motor oscillation at the initial value due to load conditions, etc., first lower the speed gain value before put into practice.)

#### 2. Decrease the speed gain value by 1 from the state where abnormal noise is generated until there is no abnormal noise, etc., and determine the upper limit of the speed gain.

#### 3. Set the value (\* 1) lowered by "2" from the determined upper limit value as the speed gain setting value.

After setting, operate continuously. Make sure that no abnormal noise is generated during operation or stop. If abnormal noise occurs, lower the set value.

\* 1: If the upper limit of the speed gain value that does not cause an abnormality is "20", set "2" lowered, "18".

### (2) Position gain setting

To increase the position gain value, set as follows.

By increasing the position gain, the cycle time will be shortened, but shaking and abnormal noise will be more likely to occur when decelerating and stopping.

#### 1. Be sure to perform the confirmation operation.

Increase the position gain value by 3 to 5 until abnormal noise or abnormalities such as shaking begin to occur during operation.

#### 2. Decrease the position gain value by 1 or 2 from the state where an abnormality has occurred to the state where there is no abnormality, and determine the upper limit of the position gain.

#### 3. Set an integer value (\* 2) that is 10% lower than the determined upper limit value as the position gain value.

After setting, check that there are no abnormalities in continuous operation. If there is something abnormalities, lower the set value.

\* 2: If the upper limit of the position gain value that does not cause an abnormality is "35", lower it by 10% and round down to the nearest whole number, and set "31" as the set value. (The gain setting can only be set to an integer value)

### CAUTION

- Checking the operation while energizing is dangerous work. Be sure to take the safety measures described in the section of ■ 1.2 "For your safe operation".
- If you accidentally change the parameter settings that you did not intend, the behavior may be unexpected. Be sure to check the items to be changed before implementing.
- If the parameter value is changed significantly, vibration / shaking or abnormal noise may occur. Be sure to change the value little by little and check the operation.

- Abnormalities such as vibration and abnormal noise may occur due to resonance, so check the operation from the low speed range used for return to origin operation and "JOG" operation to the high speed range used for continuous operation.
- By shortening the cycle time, an "overload error" or an abnormality due to overheating of the motor may occur. If an error occurs, consider changing the motor capacity or operating conditions.
- For the combined specification axes, adjust the servo gain for all axes.  
If all the axes have not been adjusted, the amount of deviation in the operation trajectory of the interpolation operation may increase or the positioning may be delayed due to the operation of the axis that has not been adjusted.

## Chapter 7 Maintenance

### ■ 7.1 Precautions for inspection and maintenance work

#### (1) Precautions for inspection and maintenance work

Observe the following instructions at the time of inspection and maintenance:

1. The robot shall be inspected and maintained by the personnel having a sufficient level of skill and experience.  
If such personnel are not available, contact the manufacturer and request implementation of the relevant work or education of the person in charge.
2. Use adequate illumination.
3. The start switch of the stationary operation panel or some other similar portion shall be provided with a notice board to indicate that the inspection and maintenance work is currently in progress.  
Before entering the fence and enclosure, lock the open power switch to turn off power completely. If the access of the fence or enclosure is provided with a safety plug, be sure to carry the related plug with you.
4. If you have to enter the fence and enclosure for inspection and inspection of the control circuit, turn off the drive power source.
5. If you have to operate the industrial robot in the inspection and maintenance work within the guard fence and enclosure, you are recommended to take the following measures:
  - Two persons should be engaged in the work in cooperation with each other. This means that role assignment should be made in such a way that one person supervises the work of the other person during the work.
  - It is required to select such a speed that contact with the robot can be avoided in the event of a possible operation error of the robot. Determine the speed suited for the relevant work.
  - Take care of the robot operation during the work. Press the emergency stop button immediately when an unexpected operation has been detected.
6. Before starting disassembly of the pressure gauge or replacement of the parts, release the residual pressure of the cylinder.
7. Before starting disassembly of the hydraulic and pneumatic systems or replacement of parts, take a sufficient care to avoid deposition or mixture of foreign substances such as dust.

#### (2) Action to be taken subsequent to inspection and maintenance work

1. After termination of the inspection or maintenance work, the inspection or maintenance worker shall carry the tools back to the original position.
2. After termination of the maintenance work, be sure to perform a test run to verify the result. The test run shall be performed from outside the fence and enclosure in principle.
3. After action of item 2 has been taken, the inspection or maintenance worker shall report termination of the inspection or maintenance work to his superior.

## ■ 7.2 Inspection before starting the work

- (1) Before starting your work with the robot, make sure of the following:
  1. Brake device function
  2. Emergency stop device function
  3. Contact preventive equipment and robot interlock function
  4. Related devices/robot interlocking function
  5. Possible damage of the external wiring and piping
  6. Error of supply voltage and hydraulic and pneumatic pressures
  7. Operation error
  8. Abnormal noise and vibration
  9. Contact preventive equipment state
- (2) This inspection shall be conducted outside the movable range wherever possible.

## ■ 7.3 Periodic inspection

Giving consideration to the robot installation site, frequency of use and durability of the parts, determine the inspection standards including the inspection item, inspection procedure, evaluation criteria and implementation period for the following items. Start inspection in conformity to these standards.

1. Looseness of major parts
2. Lubrication and other possible errors of the movable parts
3. Power transmission component trouble
4. Hydraulic and pneumatic system error
5. Electric system error
6. Operation failure detecting function error
7. Encoder error
8. Servo system error



## ■ 7.4 Maintenance Schedule

Perform the pre-work inspection before starting work on a daily basis.

Periodic inspections and maintenance performed after a certain period of time should be performed in units of 1200 hours (operating hours). Also, please carry out overhaul every 24000 hours (operating hours).

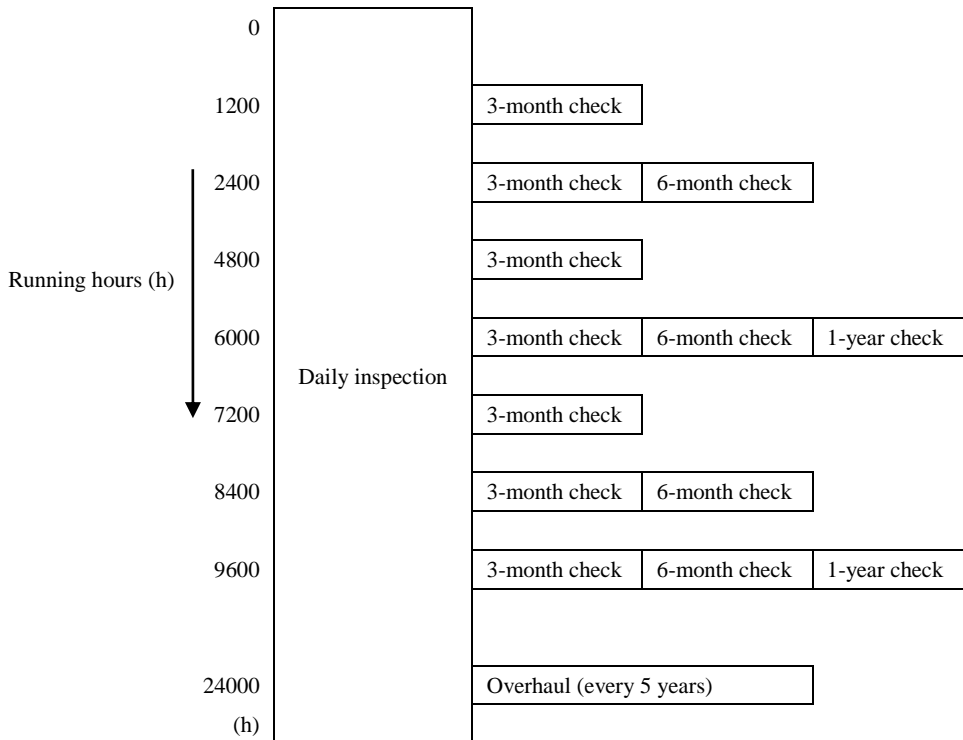

### Regular Inspection interval (reference)

When the system is operated for 16 hours per day:  $1,200 \text{ hours} \div 16 \text{ hours} \div 25 \text{ days} = 3 \text{ months}$

When the system is operated for 24 hours per day:  $1,200 \text{ hours} \div 24 \text{ hours} \div 25 \text{ days} = 2 \text{ months}$

When the system is operated for 16 hours per day, regular inspection should be conducted every three months. However, if the running hours per day are increased, regular inspection must be done at shorter intervals.

Please inspect the timing belt according to Section 7.7.

## ■7.4.1 Maintenance and inspection items by schedule

Determine the schedule for Inspection before starting the work and periodic inspection and maintenance.

### (1) Inspection at Power OFF

Description	Inspection point	I: Inspection before starting the work S: Semi-annual inspection				Q: Quarterly inspection A: Annual inspection	
		I	Q	S	A		
Make sure that all bolts are completely tightened and secured. If there are any loosened or unsecured bolts, re-tighten them.	Tool set bolts	○	○	○	○		
	Robot installation bolts	○	○	○	○		
	Slider set bolts					○	
	Linear guide set bolts					○	
Make sure that the cables and tubing are not damage.	Cables and air tubing	○	○	○	○		
Check each axis operation. Move each axis by hand for check.	Entire robot			○	○		
Clean the contaminant, if any. Make sure that no cut or scratch is found. Refer to ■7.5	Entire robot	○	○	○	○		
Please check the condition of the grease. Greasing Refer to ■7.6	Linear guide, Resin on slider	○	○	○	○	○	
Please inspect the timing belt. Refer to ■7.7	Timing belt	○	Inspection every 500 hours				

### (2) Inspection at Power ON

Description	Inspection point	I: Inspection before starting the work S: Semi-annual inspection				Q: Quarterly inspection A: Annual inspection	
		I	Q	S	A		
Push each axis by hand in the servo ON condition to make sure that the slider is secured.	Slider					○	
Make sure that no abnormal vibration or noise is caused.	Entire robot	○	○	○	○		
Make sure that the teaching points are in place.	Positioning of slider		○	○	○		
Replace the batteries for position detection with new ones.	Battery for encoder backup (Attached to CA25 controller)	Replace every 3 years					
Operation check of emergency stop device and safety devices.	Emergency stop switch Safety fence switch	○	○	○	○		
Anomaly confirmation of supply voltage, supply hydraulic pressure and air pressure.	Power-supply voltage, Hydraulic pressure and air pressure	○	○	○	○		

### (3) Overhaul

Description	Maintenance parts	Every 5 years
Check the consumable parts and replace as necessary.	Motor, Linear guide, Controller cable (When used in movable), Battery for encoder backup	○

Please overhaul the timing belt according to Section 7.7.

Depending on the device, add necessary items and perform inspection and maintenance.

## ■7.5 Cleaning

Clean the robot proper in conformity to the following steps:

1. Turn off the power switch and remove the power plug.
2. Use waste cloth or such to remove the dust and dirt from the frame and covers etc.
3. Remove the frame cover and clean the dust and dirt from the frame cover. After that, supply oil for lubrication.
4. Mount the frame cover back.

## ■7.6 Greasing

- Greasing positions

The linear guide of this product are provided with an oilless seal. To prevent a possible accident, check for the greasing conditions and damages on a periodic basis. If insufficient lubrication has been found out, supply grease according to the following steps. If any trouble such as a breakdown has been detected and repair work is required, contact the Service Divisions shown at the end of this Manual, and request repair to be made.

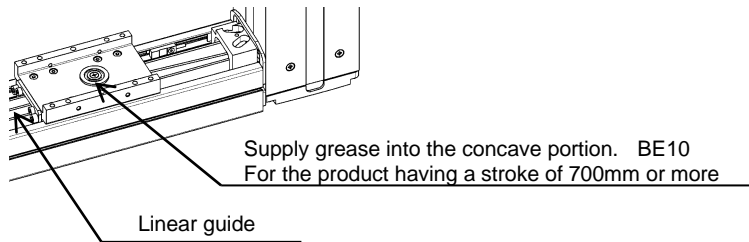

Greasing position	Type of grease (manufacturer)	Inspection and greasing intervals	Volume of grease
Linear guide	Albania Grease S2 (Shell Lubricants Japan)	Every 6 months	A thin layer of grease applied on the linear guide rail
Resin on slider			Fill the groove.

- Inspection and greasing steps

1. Turn off the power and remove the power plug.
2. Remove the frame cover of the axis.
3. Inspect the linear guide . If insufficient greasing has been found out, supply grease to the above-mentioned greasing positions.
4. Slowly move the slider manually or in the jog mode (at a speed of about 50 mm per second or less) five or more reciprocations and make sure that grease has been supplied into the linear guide block.
5. Wipe off the overfilled or discolored grease.
6. Mount the frame cover again.

**CAUTION**

If the fats and oils in the belt is attached, please be sure to wipe it will be the cause of the deterioration of the belt.

## ■ 7.7 Timing belt inspection

Inspect the timing belt at intervals of approximately 500 hours.

- Check the belt for deterioration, fatigue and scratches. Replace it if any problem has been detected. For the replacement procedure, see section 7.8.

## ■ 7.8 Timing belt and motor replacement procedure

Replace the timing belt and motor in conformity to the following steps:

For the belt tension adjustment procedure, see Section 7.10 Routing the timing belt as well.

### ▲ CAUTION

- Turn OFF power before starting the work.
- When the belt tension has been adjusted, the programmed position (teaching position) may be misaligned. If it is misaligned, correct the programmed position (teaching position).

(1) Remove the cover.

(When you want to replace the motor for the 21 mm-lead product alone, you need not remove the frame cap or end plate.)

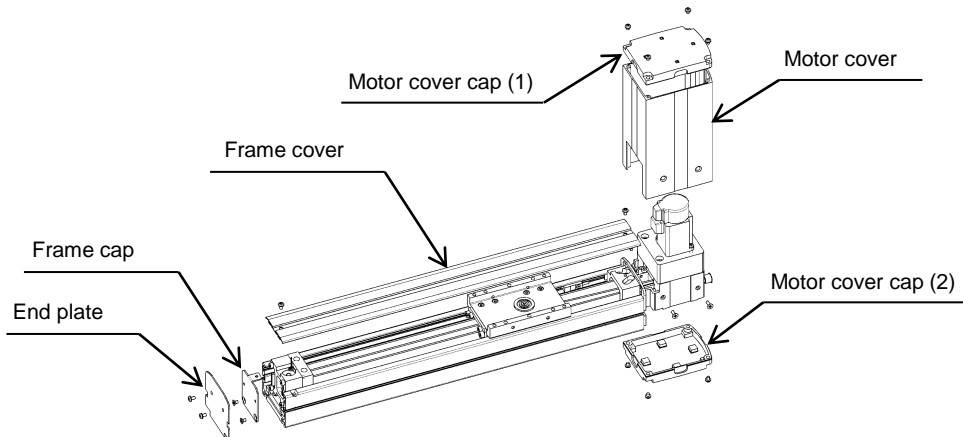

- (2) Loosen two belt clamp bolts and reduce the timing belt tension.  
 (This step is not necessary if you want to replace the motor for the 21 mm-lead product alone.)

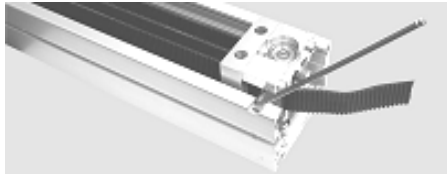

Motor facing upward

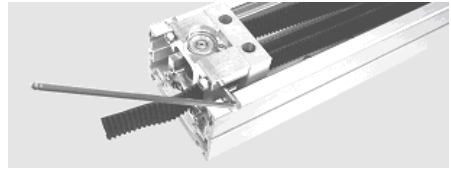

Motor facing downward

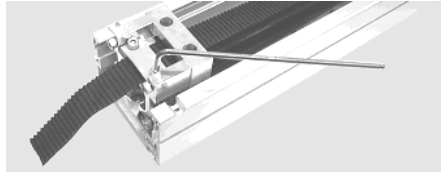

Motor facing rightward

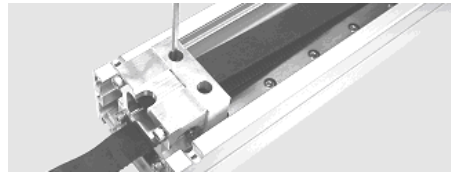

Motor facing leftward

- (3) Loosen the bolt on the motor output shaft side of the coupling located inside, from the hole of the motor spacer.  
 (For the 42 mm-lead product, this work is not necessary.)

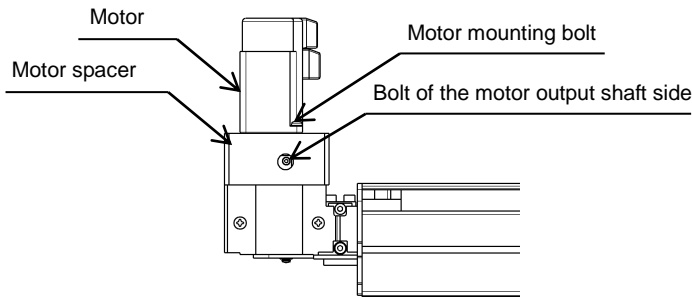

- (4) Remove the motor mounting bolt. Then remove the motor (21 mm-lead product with inertia damper, 42 mm-lead product with pulley and bearing) from the axis.  
 If you want to replace the motor alone, go to step (12).

- (5) Remove the belt clamp proper from the motor block.

- For 21 mm-lead product

Loosen the motor spacer mounting screw, and remove the motor spacer from the motor block.

Loosen the belt clamp mounting screw on the motor block side and remove the belt clamp proper from the motor block.

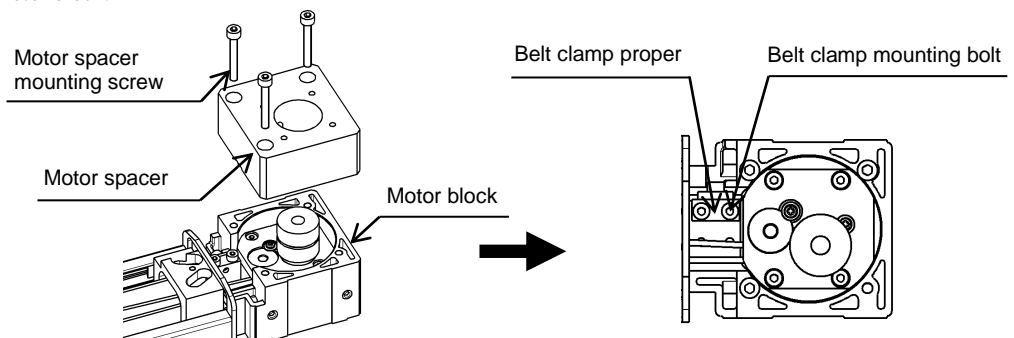

- For 42 mm-lead product  
Loosen the belt clamp mounting screw on the motor block side and remove the belt clamp proper from the motor block.

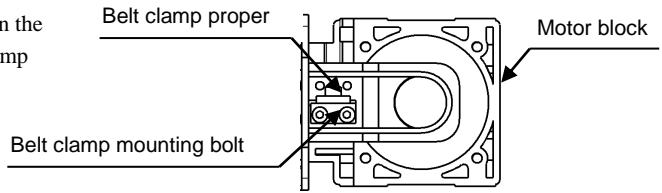

- (6) Remove the screw of the sheet metal fixing the belt of the belt clamp on the motor block side. Then remove the belt.
- (7) Pull the end of the belt and remove the belt from the axis.
- (8) Pull out the prepared belt from the motor block and mount it again on the belt clamp.  
Fix the belt so that it will be protruded one thread from the belt clamp.  
Attach the belt at a right angle to the belt clamp body.  
(Mount it so that it is parallel to the mounting surface.)

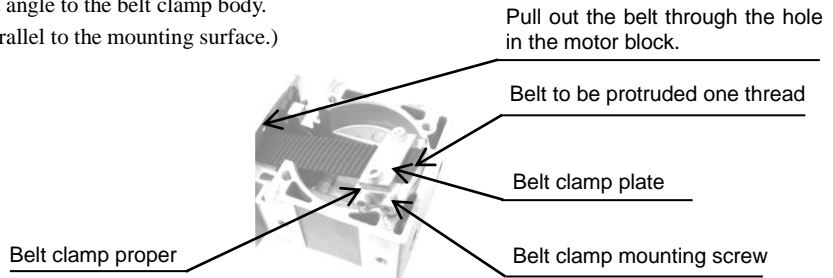

**CAUTION**

The tension of the belt may cause the belt to come off from the belt clamp.  
Be sure to pull out 1 tooth of the belt from the belt clamp plate and fix it.

- (9) The belt clamp proper on the motor block side shall be mounted on the motor block.  
(Tapped hole outside the motor block outside for 21 mm-lead product, and tapped hole at the center of the motor block outside for 42 mm-lead product; See 7.7(5))
- (10) Route a new timing belt in the order of the slider block (motor side), inside the motor block, end block, slider block (end side) and end side belt clamp proper. It should be noted that routing of the motor varies according to the motor mounting direction and lead (See 7.8).

- For 21 mm-lead product  
Loosen the motor bracket mounting screw and remove the motor bracket from the motor block. If the belt has been routed, mount the motor bracket on the motor block  
(See 7.8.1).

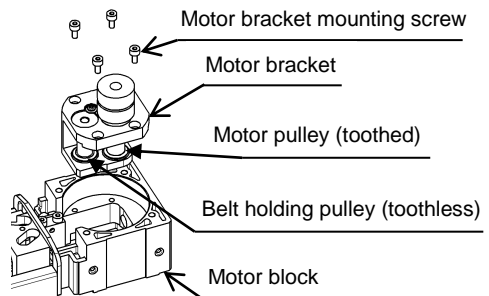

- For 42 mm-lead product  
Turn back the timing belt within the motor block so that it can be applied to the pulley (See 7.8.2).

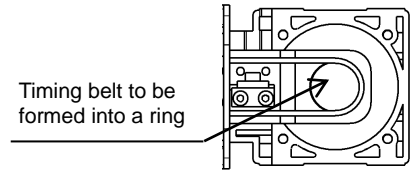

**CAUTION**

Do not allow the belt to be twisted.

- (11) For the 21 mm-lead product, mount the motor spacer on the motor block.  
(The 42 mm-lead product is not provided with a motor spacer).

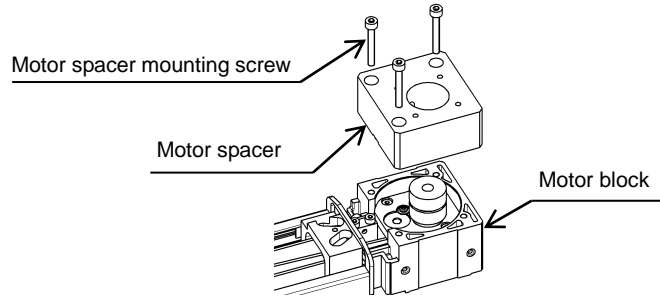

- (12) Connect the motor with the controller on the temporary basis. Then connect the teaching pendant to the controller, and return the axes to the origin.
- (13) The motor rotates. Taking care not to touch the rotating part, move the slider close to the origin. If the origin sensor has detected the slider, the motor starts the stop operation at the time of return to the origin.
- (14) After the motor has stopped (completion of return to origin), move the slider so that the distance between the slider and plate will be 34 mm.  
Turn off the controller power and mount the motor on the motor block using the original screw.

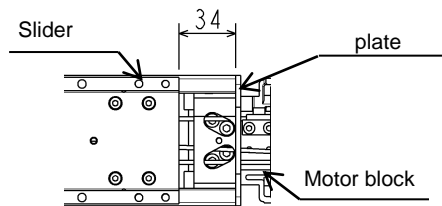

- (15) Tighten the motor mounting screws uniformly little by little so the motor will not be tilted. The motor lead wire should be oriented toward the slider.  
Tighten the coupling bolt of the 21mm lead product with the torque described below.  
BE10E (100W motor specification): 1.0 to 1.1N·m  
BE10F (200W motor specification): 1.5 to 1.9N·m

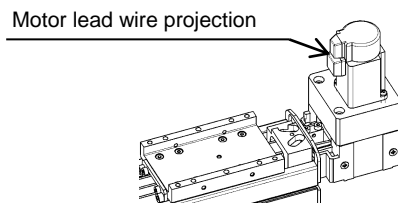

- (16) Mount the motor on the motor block, and loosen four bearing clamping plate screws on the bottom of the motor block. Make sure that the bearing clamping plate rotates a little about the bearing. After that, uniformly retighten bearing clamping plate mounting screws having been loosened. Make sure that there is no misalignment between the motor mounting position and bearing clamping plate. (For the 21 mm-lead product, this work is not necessary).

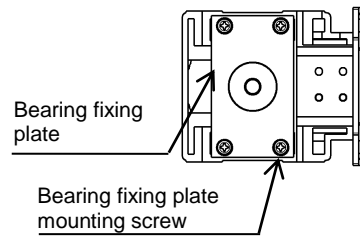

- (17) Adjust the meshing between the peak and valley of the end of the belt protruding from the belt clamp on the end block side, and bind them with a band.

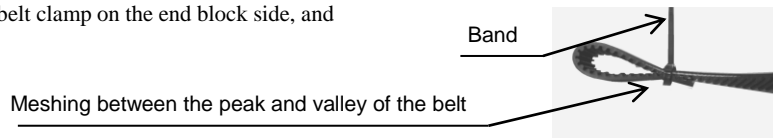

- (18) Route the hook of the spring balance through the portion where the timing belt has been turned back. Pull the timing belt with a force of 147 N (15 kgf). When the belt is kept pulled, tighten the belt clamp bolt.

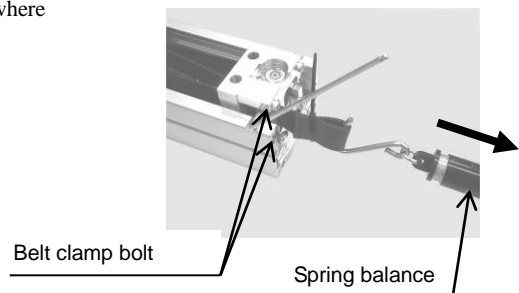

- (19) Mount the cover.

**⚠ CAUTION**

- A new timing belt may be subjected to initial elongation. When the initial elongation occurs and the belt tension has been reduced, set the belt tension back to the specified level.
- When the belt has been re-tightened, the programmed position (teaching position) may be misaligned. If this has occurred, correct the program (teaching).



## 7.9 Routing the timing belt

For the details of the motor block interior, see Section 7.7 (10).

Route the timing belt so that the belt tooth will touch the toothed pulley and the back of the belt will touch the toothless pulley.

Take care to make sure of the directions of the motor block, end block and slider block.

### 7.9.1 Routing the timing belt for 21 mm-lead product

- Schematic view

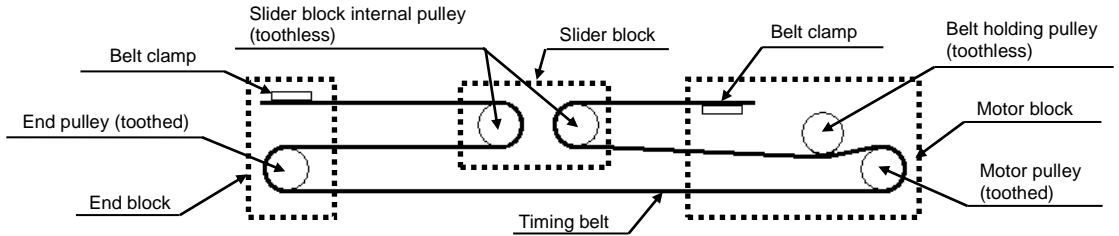

- Top side mounted motor axis

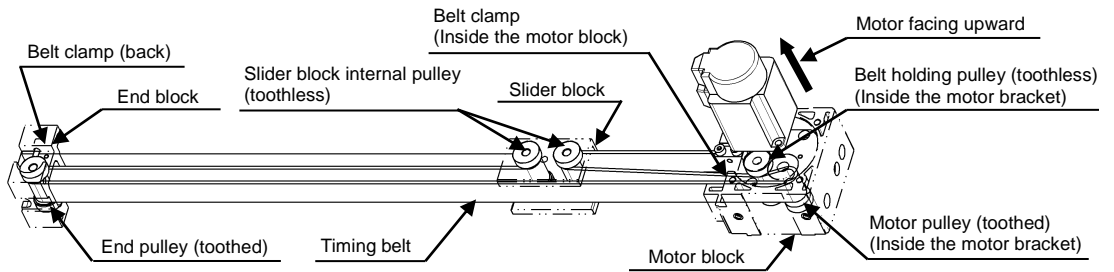

- Bottom side mounted motor axis

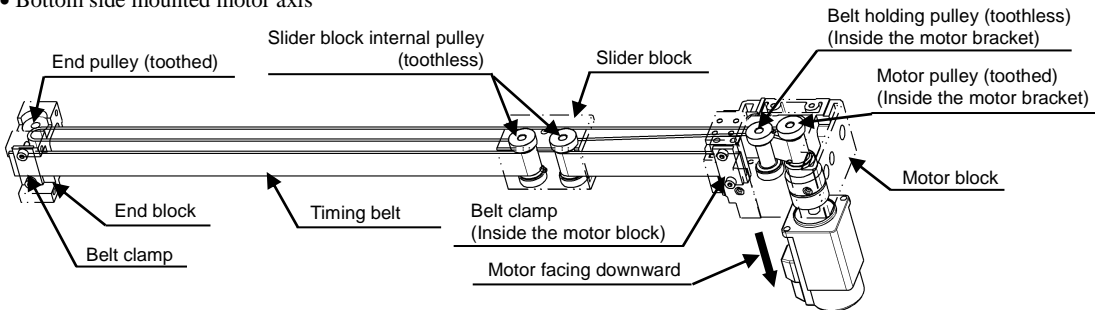

- Right side mounted motor axis

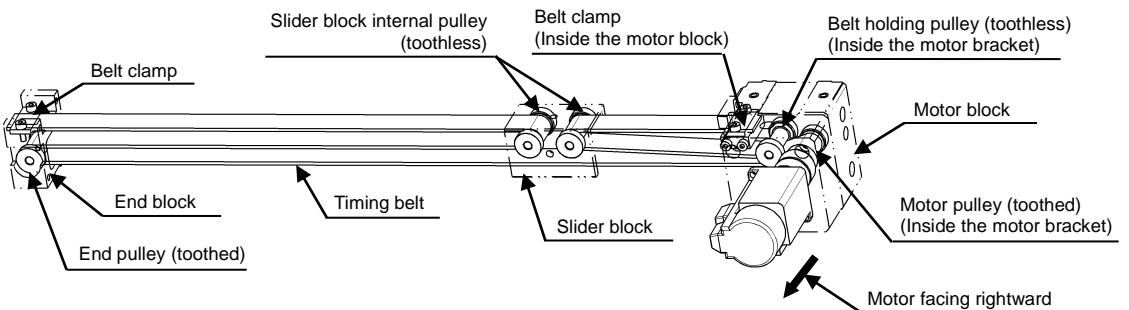

- Left side mounted motor axis (The end side belt clamp is located inside the end base.)

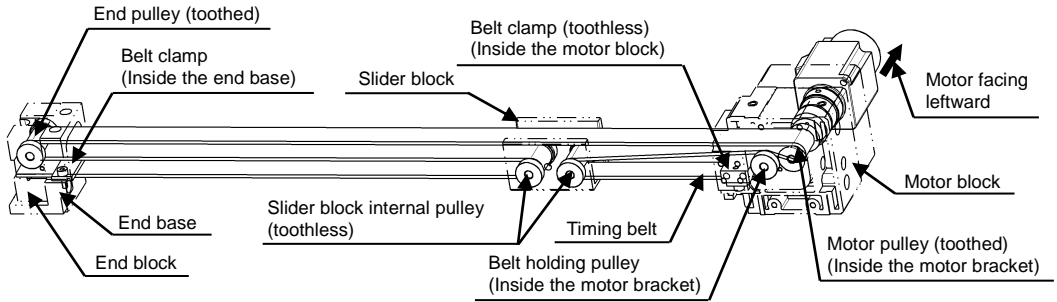

## 7.9.2 Routing the timing belt for 42 mm-lead product

- Schematic view

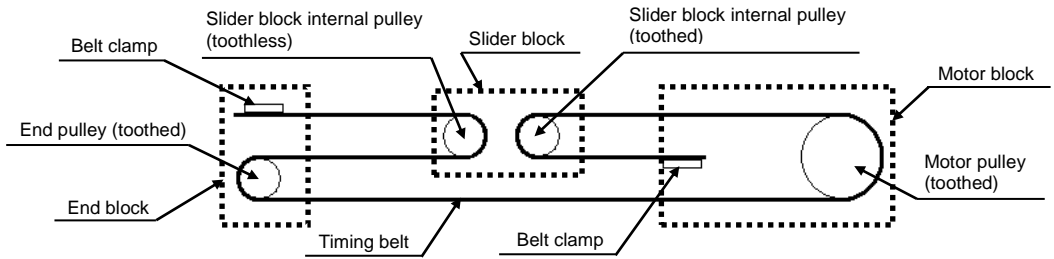

- Top side mounted motor axis

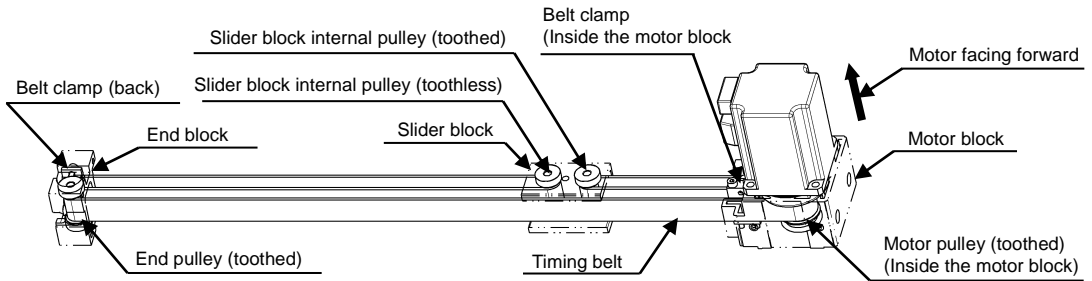

- Bottom side mounted motor axis

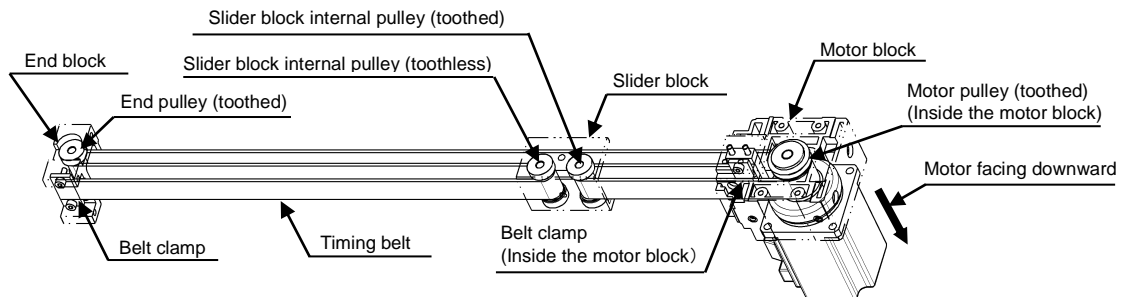

- Right side mounted motor axis

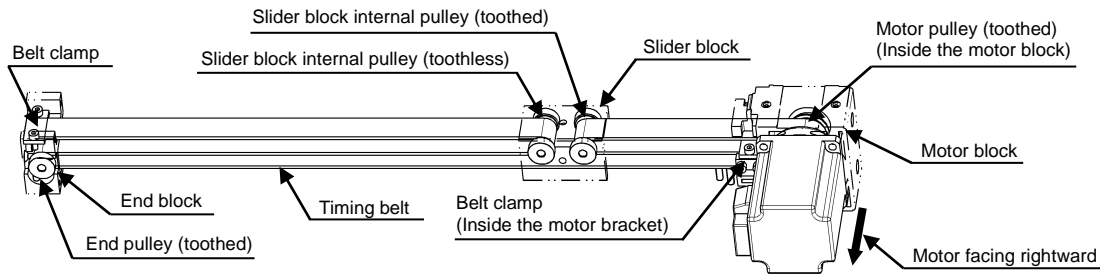

- Left side mounted motor axis (The end side belt clamp is located inside the end base.)

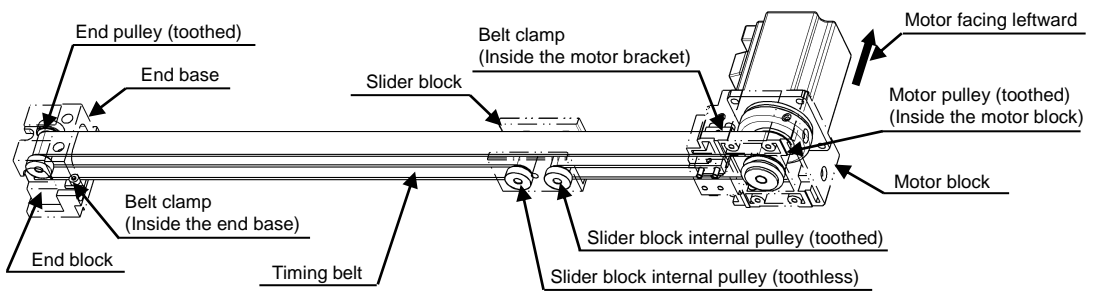

## 7.10 Origin position adjustment

Adjust the home position by the distance between the origin sensor and motor block.

The distance between the origin sensor and motor block is "A".

Applicable axis	A
BE10E(F)-B*-S	38mm
BE10E(F)-B*-M	60mm

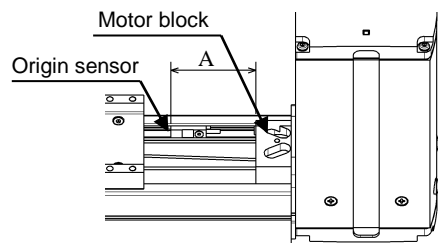

## ■7.11 Replacement of linear guide

- If the replacement of linear guide to be replaced, contact our sales office closest to your company. It must not be replaced by the customer.
- This replacement is performed for each axis. It should be noted that this replacement cannot be made inside the device or in the combined state.

## ■7.12 Bolt and screw tightening torque

For the tightening torque of bolts, etc., tighten the parts not described in the work procedure, etc. with the values in the table below.

Name	Screw size	Tightening torque (N·m)	Remarks
Hexagon socket head cap screw	M3	0.98	
	M4	2.94	
	M5	5.88	
	M6	8.82	
Pan head screw Countersunk head screw hexagon socket button head screw	M3	0.29	For fixing resin parts
	M3	0.49	
	M4	1.47	
	M5	2.94	

## Chapter 8 Spare Parts

### ■ 8.1 Spare Parts

When a trouble has occurred to the robot proper and you have found it out at an earlier stage, you cannot repair it if you have no repair parts. Accordingly, you are recommended to keep spare parts on hand.

No.	Parts number	Parts name	Remarks
1	A5150100	BA timing belt (100-500)	For strokes of 100 mm to 500 mm
2	A5150101	BA timing belt (600-1000)	For strokes of 600 mm to 1000 mm
3	A5150102	BA timing belt (1100-1500)	For strokes of 1100 mm to 1500 mm
4	A5150103	BA timing belt (1600-2000)	For strokes of 1600 mm to 2000 mm
5	A5150104	BA timing belt (2100-2500)	For strokes of 2100 mm to 2500 mm
6	A5300041	BA3-100W AC servo motor (Belt 21mm)	For BE10E belt driven axis (100W) lead 21mm , with flywheel
7	A5300042	BA3-200W AC servo motor (Belt 21mm)	For BE10F belt driven axis (200W) lead 21mm , with flywheel
8	A5300045	BA3-200W AC servo motor (Belt 42mm)	For BE10F belt driven axis (200W) lead 42mm , with flywheel and pulley

# **SHIBAURA MACHINE CO., LTD.**

**TOKYO HEADQUARTERS**

Electronic Equipment Sales Group, Control Systems Division  
2-2, Uchisaiwaicho 2-Chome, Chiyoda-ku, Tokyo 100-8503, Japan  
TEL: [81]-(0)3-0270 FAX: [81]-(0)3-3509-0335